



Electrolux
PROFESSIONAL

Modular Cooking Range Line 900XP 4-Burner Gas Range on Electric Oven Town Gas

ITEM # _____

MODEL # _____

NAME # _____

SIS # _____

AIA # _____



391195 (E9GCTH4CEM)

4-Burner (1x7,5 kW - 3x5,5 kW) gas Range on electric Oven (6 kW) - town gas

Short Form Specification

Item No. _____

To be installed on stainless steel feet with height adjustment up to 50 mm. High efficiency flower flame burners with continuous power regulation and optimized combustion. Flame failure device as standard on burners to protect against accidental extinguishing. Oven chamber with 3 levels of runners to accommodate 2/1 GN shelves (2 steam pans). Ribbed, cast-iron oven base plate. Exterior panels of unit in stainless steel with Scotch Brite finish. Pan supports in heavy duty cast iron. Extra strength work top in heavy duty 2 mm stainless steel. Right-angled side edges to allow flush-fitting junction between units.

Main Features

- Unit to be mounted on stainless steel feet with height adjustment up to 50 mm. Unit can be easily mounted on cantilever systems.
- The three 6 kW and one 10 kW high efficiency burners are available in two different sizes to suit high performing cooking requirements of the most demanding customers:
 - 60 mm burners with continuous power regulation from 1,5 to 6 kW
 - 100 mm burners with continuous power regulation from 2.2 kW to 10 kW
- Gas burners supplied for use with town gas.
- Large sized pan support in cast iron (stainless steel as option) with long center fins to allow the use of the largest down to the smallest pans.
- Burners with optimized combustion.
- Flame failure device on each burner protects against gas leakage when accidental extinguishing of the flame occurs.
- Protected pilot light.
- Base compartment consists of an electric standard oven with 40 mm thick oven door for heat insulation, positioned beneath the base plate.
- Oven chamber with 3 levels of runners to accommodate 2/1 GN shelves (2 steam pans).
- Ribbed cast iron oven base plate.
- Oven thermostat adjustable from 110 °C to 285 °C.
- The special design of the control knob system guarantees against water infiltration.
- IPX5 water protection.

Construction

- Unit is 930 mm deep to give a larger working surface area.
- All exterior panels in Stainless Steel with Scotch Brite finishing.
- AISI 304 stainless steel worktop, 2mm thick.
- Model has right-angled side edges to allow flush fitting joints between units, eliminating gaps and possible dirt traps.

Included Accessories

- 1 of GN2/1 chrome grid for static oven PNC 164250

Optional Accessories

- GN2/1 chrome grid for static oven PNC 164250
- Junction sealing kit PNC 206086
- Draught diverter, 150 mm diameter PNC 206132
- Matching ring for flue condenser, 150 mm diameter PNC 206133

APPROVAL: _____



Experience the Excellence
www.electroluxprofessional.com



• Kit 4 wheels - 2 swivelling with brake - it is mandatory to install Base support and wheels	PNC 206135	<input type="checkbox"/>	• Frontal handrail, 800mm	PNC 216047	<input type="checkbox"/>
• Flanged feet kit	PNC 206136	<input type="checkbox"/>	• Frontal handrail, 1200mm	PNC 216049	<input type="checkbox"/>
• Frontal kicking strip for concrete installation, 800mm	PNC 206148	<input type="checkbox"/>	• Frontal handrail, 1600mm	PNC 216050	<input type="checkbox"/>
• Frontal kicking strip for concrete installation, 1000mm	PNC 206150	<input type="checkbox"/>	• 2 side covering panels for free standing appliances	PNC 216134	<input type="checkbox"/>
• Frontal kicking strip for concrete installation, 1200mm	PNC 206151	<input type="checkbox"/>	• Large handrail - portioning shelf, 800mm	PNC 216186	<input type="checkbox"/>
• Frontal kicking strip for concrete installation, 1600mm	PNC 206152	<input type="checkbox"/>	• Pressure regulator for gas units	PNC 927225	<input type="checkbox"/>
• Pair of side kicking strips for concrete installation	PNC 206157	<input type="checkbox"/>			
• Single burner smooth plate for direct cooking - fits frontal burners only	PNC 206171	<input type="checkbox"/>			
• Single burner ribbed plate for direct cooking - fits frontal burners only	PNC 206172	<input type="checkbox"/>			
• Frontal kicking strip, 800mm (not for refr-freezer base)	PNC 206176	<input type="checkbox"/>			
• Frontal kicking strip, 1000mm (not for refr-freezer base)	PNC 206177	<input type="checkbox"/>			
• Frontal kicking strip, 1200mm (not for refr-freezer base)	PNC 206178	<input type="checkbox"/>			
• Frontal kicking strip, 1600mm (not for refr-freezer base)	PNC 206179	<input type="checkbox"/>			
• Pair of side kicking strips (not for refr-freezer base)	PNC 206180	<input type="checkbox"/>			
• 2 panels for service duct for single installation	PNC 206181	<input type="checkbox"/>			
• 2 panels for service duct for back to back installation	PNC 206202	<input type="checkbox"/>			
• Kit 4 feet for concrete installation (not for 900 line free standing grill)	PNC 206210	<input type="checkbox"/>			
• Flue condenser for 1 module, 150 mm diameter	PNC 206246	<input type="checkbox"/>			
• Water column with swivel arm (water column extension not included)	PNC 206289	<input type="checkbox"/>			
• Water column extension for 900 line	PNC 206290	<input type="checkbox"/>			
• Stainless steel double grid for 2 burners	PNC 206298	<input type="checkbox"/>			
• Chimney upstand, 800mm	PNC 206304	<input type="checkbox"/>			
• Back handrail 800 mm	PNC 206308	<input type="checkbox"/>			
• Back handrail 1200 mm	PNC 206309	<input type="checkbox"/>			
• Filter (inox) for fryer oil collection basin for 18lt, 23lt free standing fryers (without oil recirculation pump)	PNC 206359	<input type="checkbox"/>			
• Wok pan support for open burners (700/900)	PNC 206363	<input type="checkbox"/>			
• Base support for feet or wheels - 800mm (700/900)	PNC 206367	<input type="checkbox"/>			
• Base support for feet or wheels - 1200mm (700/900)	PNC 206368	<input type="checkbox"/>			
• Base support for feet or wheels - 1600mm (700/900)	PNC 206369	<input type="checkbox"/>			
• Base support for feet or wheels - 2000mm (700/900)	PNC 206370	<input type="checkbox"/>			
• Rear paneling - 800mm (700/900)	PNC 206374	<input type="checkbox"/>			
• Rear paneling - 1000mm (700/900)	PNC 206375	<input type="checkbox"/>			
• Rear paneling - 1200mm (700/900)	PNC 206376	<input type="checkbox"/>			
• Kit town gas nozzles (G150) for 900 gas boiling top	PNC 206384	<input type="checkbox"/>			
• Chimney grid net, 400mm (700XP/900)	PNC 206400	<input type="checkbox"/>			
• Side handrail-right/left hand (900XP)	PNC 216044	<input type="checkbox"/>			

Front

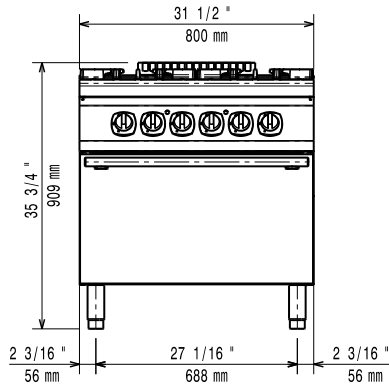

Side

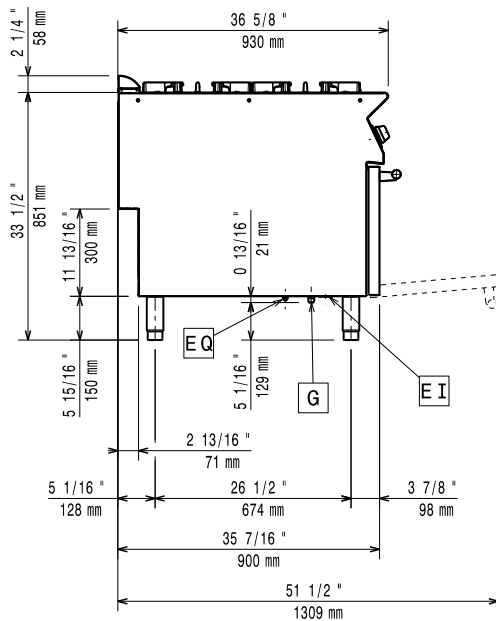

EI = Electrical inlet (power)
 G = Gas connection

Top

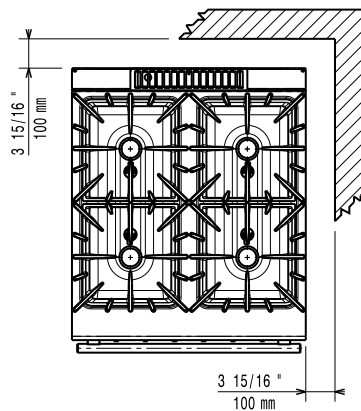

Electric

Predisposed for:

391195 (E9GCTH4CEM)

380-400V 3N- 50/60Hz
 5.5-6kW

Gas

Gas Power: 28 kW
 Standard gas delivery: Natural Gas G20 (20mbar)
 Gas Type Option: LPG; Natural Gas; Town
 Gas Inlet: 1/2"

Key Information:

Front Burners Power: 5.5 - 5.5 kW
 Back Burners Power: 5.5 - 7.5 kW
 Back Burners Dimension - mm: Ø 60 Ø 100
 Front Burners Dimension - mm: Ø 60 Ø 60
 Oven Heat Input: 6 kW
 Oven working Temperature: 110 °C MIN; 285 °C MAX
 Oven Cavity Dimensions (width): 575 mm
 Oven Cavity Dimensions (height): 300 mm
 Oven Cavity Dimensions (depth): 700 mm
 External dimensions, Width: 800 mm
 External dimensions, Depth: 930 mm
 External dimensions, Height: 850 mm
 Net weight: 155 kg
 Shipping weight: 180 kg
 Shipping height: 1120 mm
 Shipping width: 1020 mm
 Shipping depth: 860 mm
 Shipping volume: 0.98 m³
 Certification group: N9CT

If appliance is set up or next to or against temperature sensitive furniture or similar, a safety gap of approximately 150 mm should be maintained or some form of heat insulation fitted.